

(4) Mounting Holes for M6 [1/4"] Screws. See Detail A for top mounting hole dimensions.

(2)-Lifting Holes Ø20 [Ø0.79]
 Note: Spreader bar required to avoid damage during lifting

Center of Gravity
 Note: Dimensions shown are measured from the bottom left mounting hole

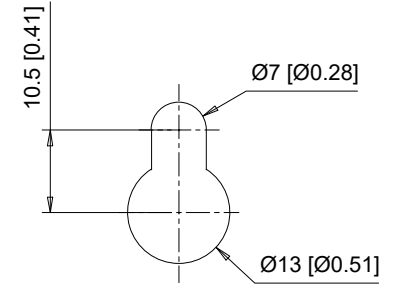
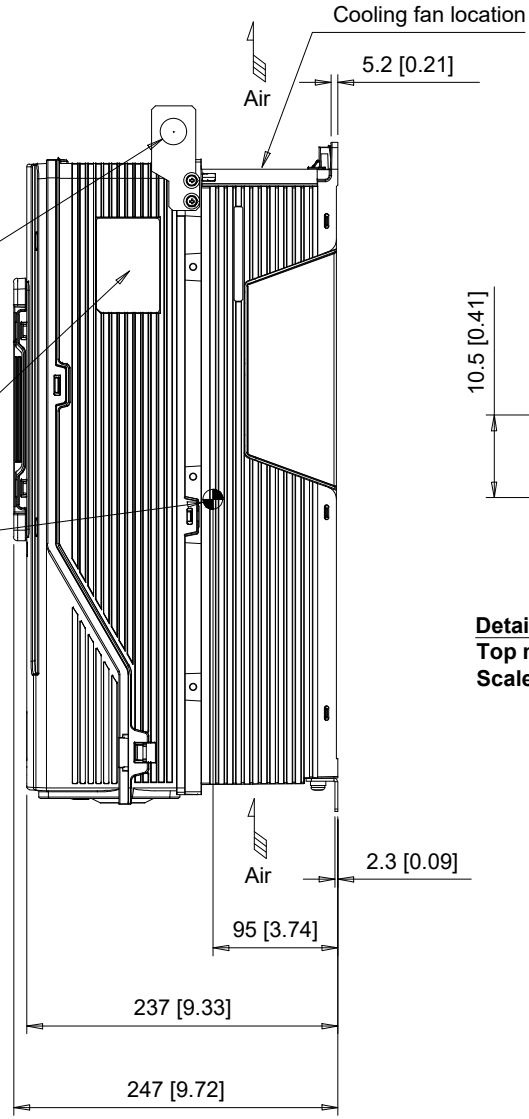

Detail A
 Top mounting hole dimensions
 Scale 1:1

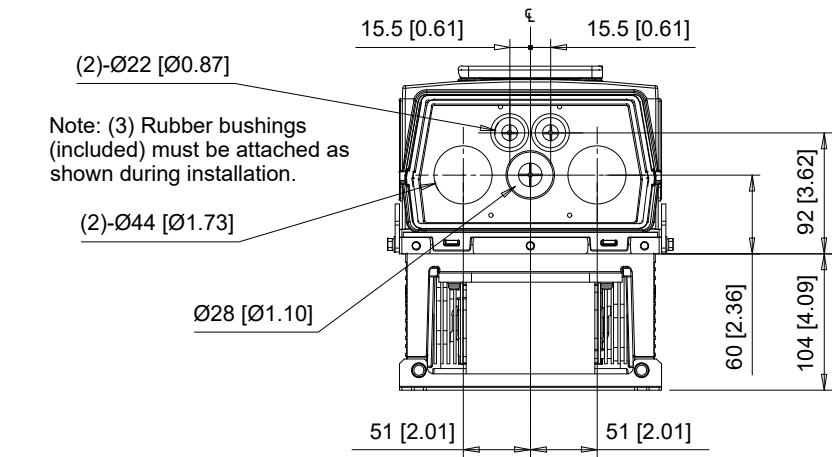

C/C: FP65□	INPUT VOLTAGE 3-PHASE (VAC)	WEIGHT Kg (lb)		COOLING FANS
		STANDARD	WITH EMC FILTER	
2046□□□	200 TO 240	14 (30.9)	15 (33.1)	1
2059□□□		15 (33.1)	16 (35.3)	1
4040□□□		15 (33.1)	16 (35.3)	1
4052□□□	380 TO 480	17 (37.5)	18 (39.7)	1
4065□□□		19 (41.9)	20 (44.1)	1

□ denotes A-Z

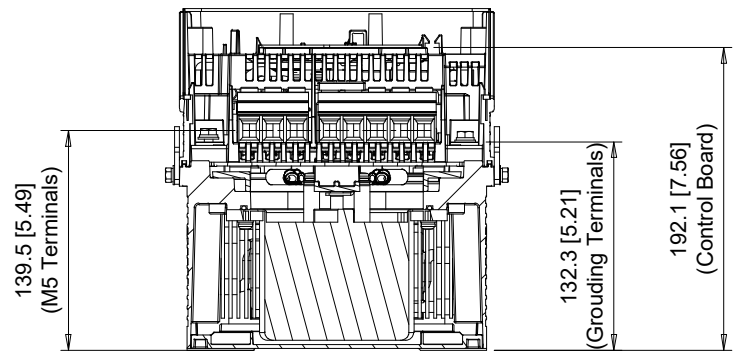
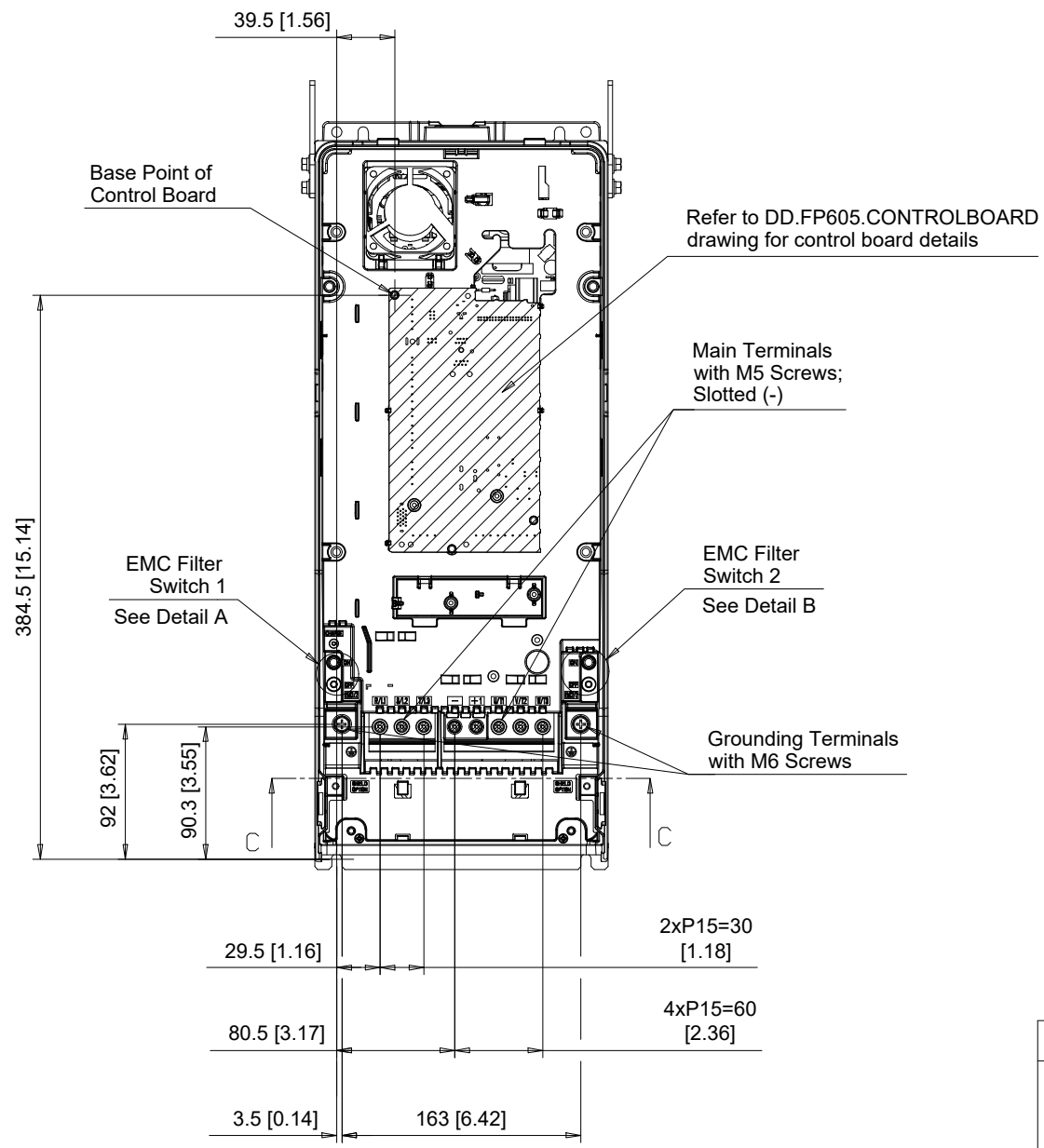

Section C-C

EMC FILTER SWITCHES

Note: EMC filter switches enabled only on models with built-in EMC filter

EMC SW1

EMC SW2

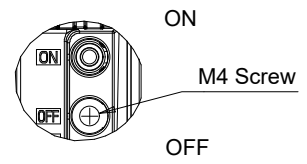
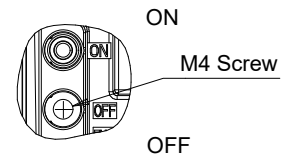

Detail A
Scale 1:2

Detail B
Scale 1:2

C/C: FP65□	TERMINAL SYMBOL	WIRE RANGE AWG (mm ²)	TERMINAL SCREW	CLAMPING TORQUE N.m. (lb.in.)
2046□□□	R/L1, S/L2, T/L3	8 - 2 (10 - 35)	M5	4.5 (40)
2059□□□	U/T1, V/T2, W/T3	8 - 2 (10 - 35)	M5	4.5 (40)
4040□□□	-, +1	8 - 2 (10 - 35)	M5	4.5 (40)
4052□□□	⊕	14 - 4 (2.5 - 25)	M6	4.0 - 5.0 (35 - 44)
4065□□□				

□ Denotes A-Z

Note: Refer to applicable codes and standards for proper wire type and size.



UNITS MM [IN]
SCALE 1:5

DRWN. J. MATTAS 3-28-22
CHKD. J. PIOTROWSKI 3-30-22
TECH. L. UDDIN 4-3-22
APRV. J. CAIRO 4-21-22

TITLE
FP605 DIMENSION DRAWING
FRAME SIZE 3
IP55/UL TYPE 12 ENCLOSURE

SIZE A PAGE 2 OF 3
DWG.NO. DD.FP605.FR3.T12

REV 0

Minimum Installation Clearances

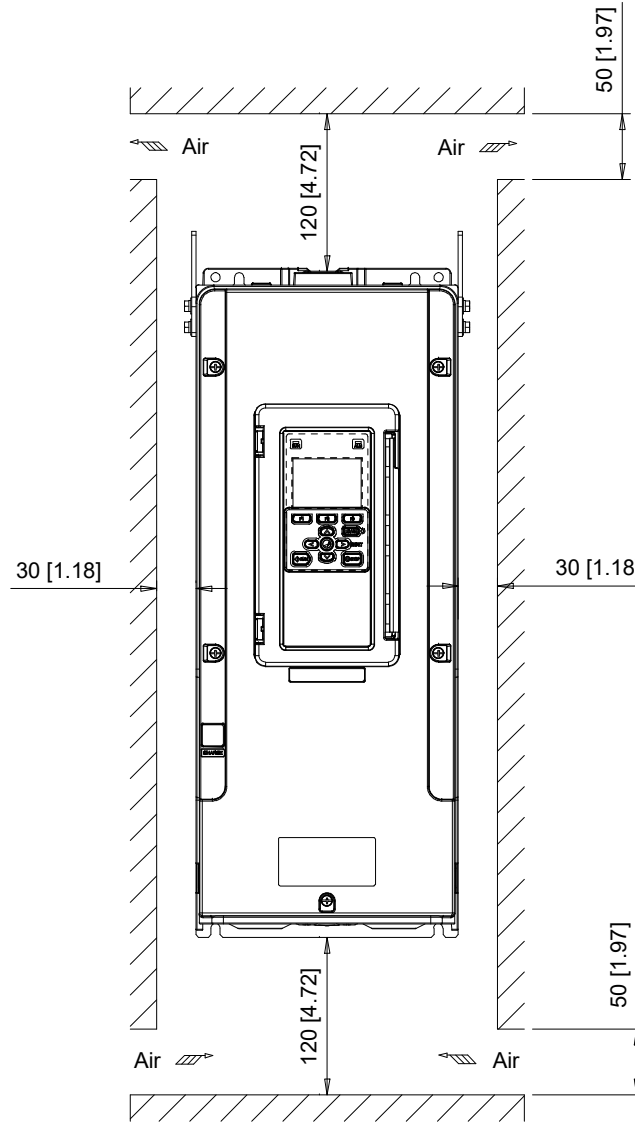

Note:
For alternate mounting configurations, consult manual.

YASKAWA

UNITS	MM [IN]
SCALE	1:6

DRWN.	J. MATTAS	3-28-22
CHKD.	J. PIOTROWSKI	3-30-22
TECH.	L. UDDIN	4-3-22
APRV.	J. CAIRO	4-21-22

TITLE	FP605 DIMENSION DRAWING FRAME SIZE 3 IP55/UL TYPE 12 ENCLOSURE
-------	--

SIZE	A	PAGE	3 OF 3
DWG.NO.	DD.FP605.FR3.T12		

REV
0